

ASSEMBLY INSTRUCTIONS











383-000027



IMPORTANT

PLEASE READ BEFORE YOU CONTINUE FURTHER

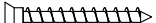
1. MATERIAL USE LAMINATED PARTICLE BOARD, TO CLEAN USE SOFT, DRY CLOTH.
2. DO NOT USE DETERGENT OR CHEMICAL AVOID CONTACT WITH WATER AND DIRECT SUNLIGHT.
3. TO BE ASSEMBLED ON A SOFT, DRY, CLEAN SMOOTH SURFACE.
4. DO NOT USE ANY TOOLS OTHER THAN THOSE SHOWN.
5. USE OF POWER TOOLS TO ASSEMBLE THIS PRODUCT WILL INVALIDATE ANY CLAIM AND MAY DAMAGE THIS PRODUCT MAKING IT UNSAFE.
6. BEFORE STARTING ASSEMBLY PLEASE VERIFY IF ALL PARTS AND HARDWARE ARE INCLUDED.

HARDWARE LIST			QTY (pcs)
DH8		Door Hinges 5/8	6
DR2		Door Stopper	1
DW4		Wood Dowel 6 x 25mm	14
HD3		Hande 96mm	2
LG7		PVC Square Leg 40mm	4
MF2		Nail	40 (+3)
SC3		Screw M3.5 x 14mm	44
SC11		Screw M4 x 25mm	4
SC25		FH Screw M5 x 40mm	14
SH4		Plastic Shelf Support with Steel Pin	24

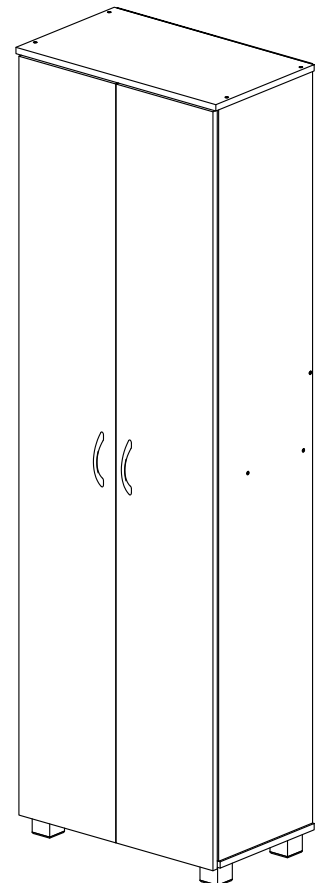

Parts List		QTY
A	Side Panel (L)	1 pc
B	Side Panel (R)	1 pc
C	Door Panel	2 pcs
D	Top Panel	1 pc
E	Free Shelf Panel	6 pcs
F	Small Shelf Panel	1 pc
G	Bottom Panel	1 pc
H	Crossbar Panel	1 pc
I	Backboard	2 pcs

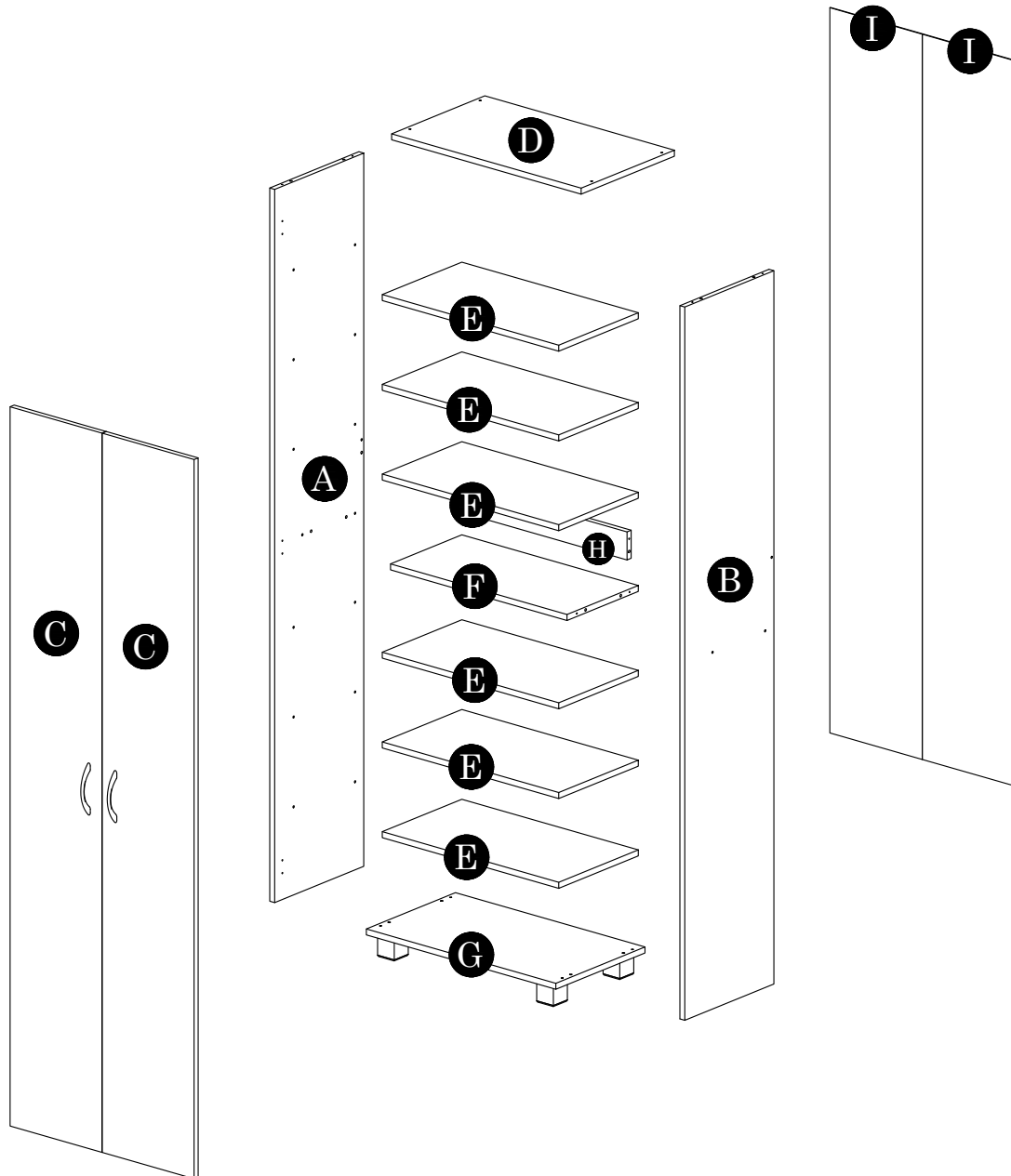

STEP 1

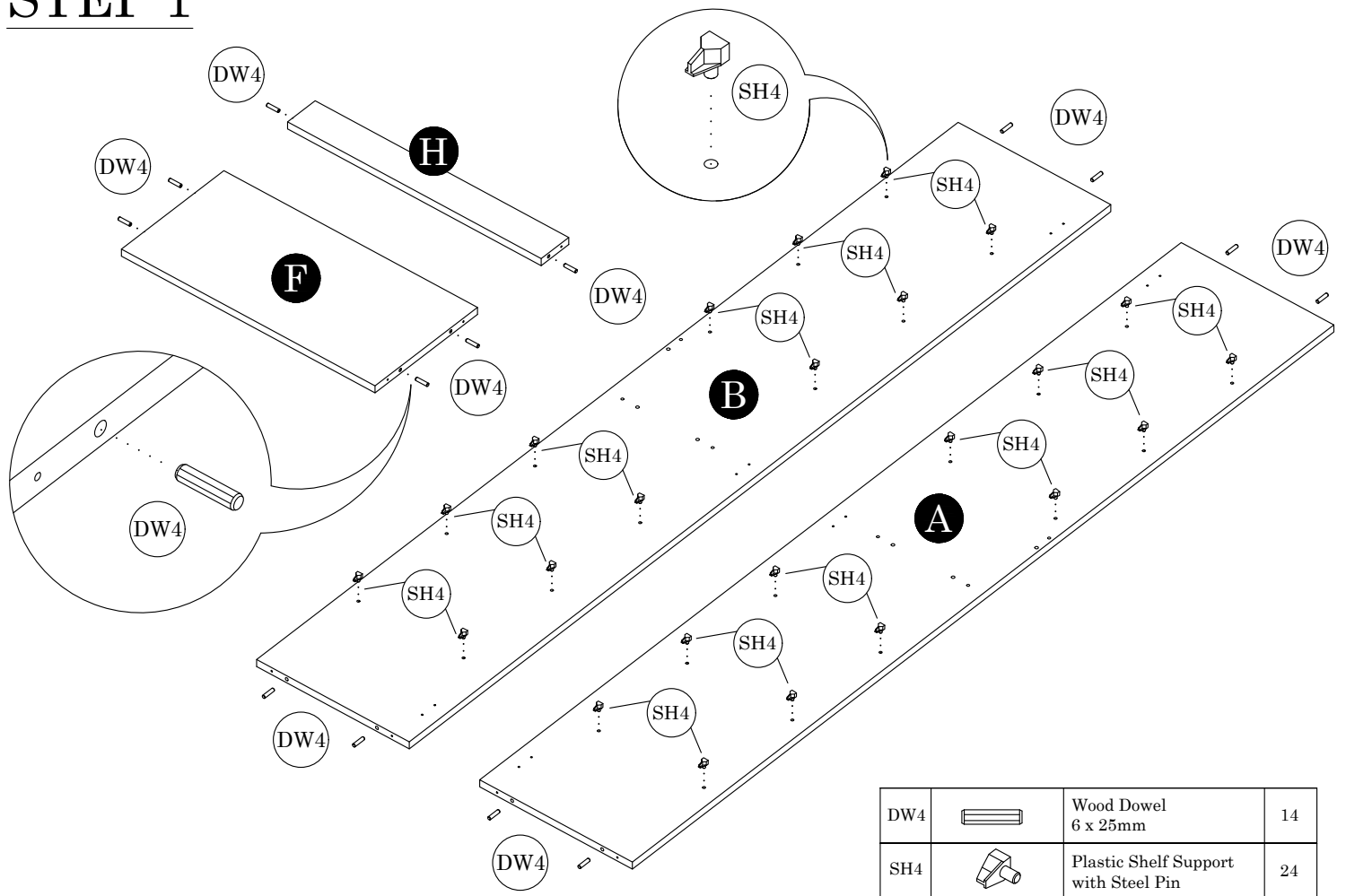

DW4		Wood Dowel 6 x 25mm	14
SH4		Plastic Shelf Support with Steel Pin	24

STEP 2

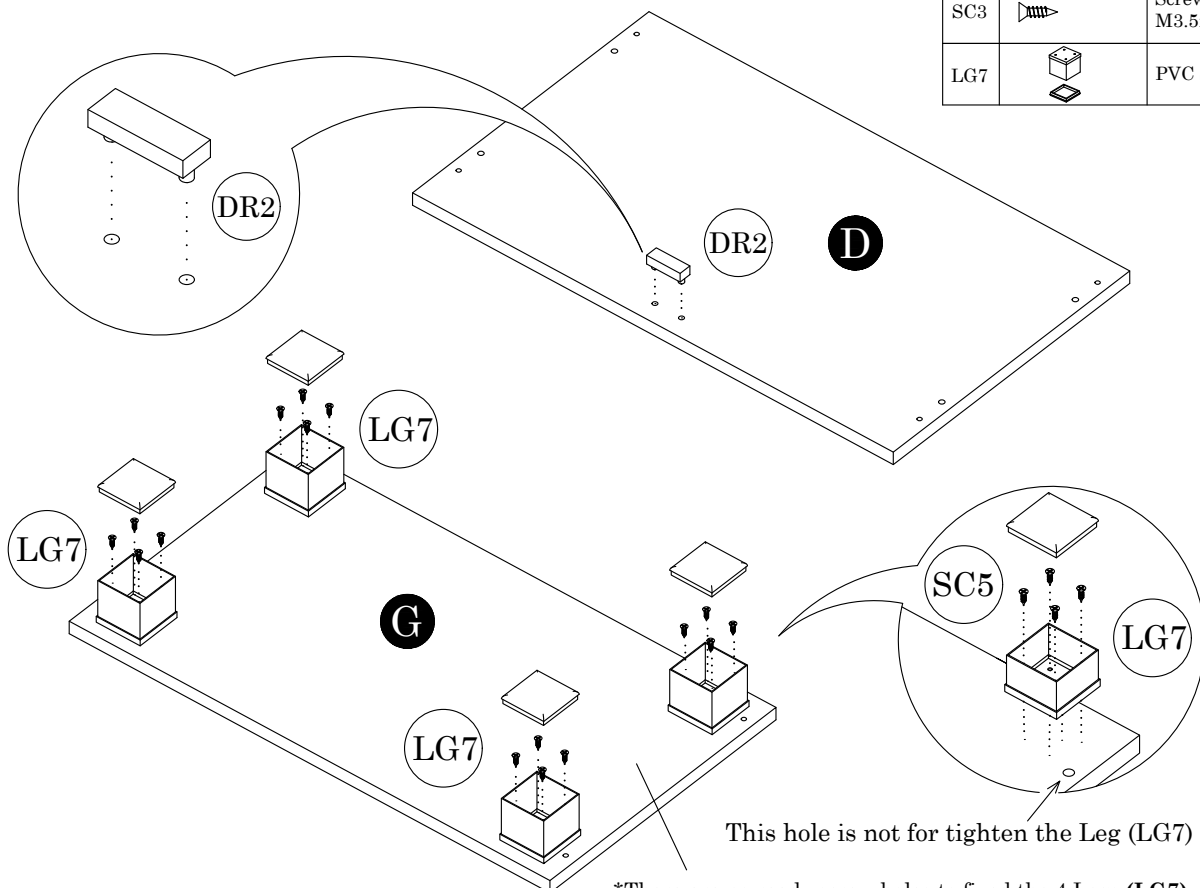

DR2		Door Stopper	1
SC3		Screw M3.5mm x 14mm	16
LG7		PVC Square Leg 40mm	4

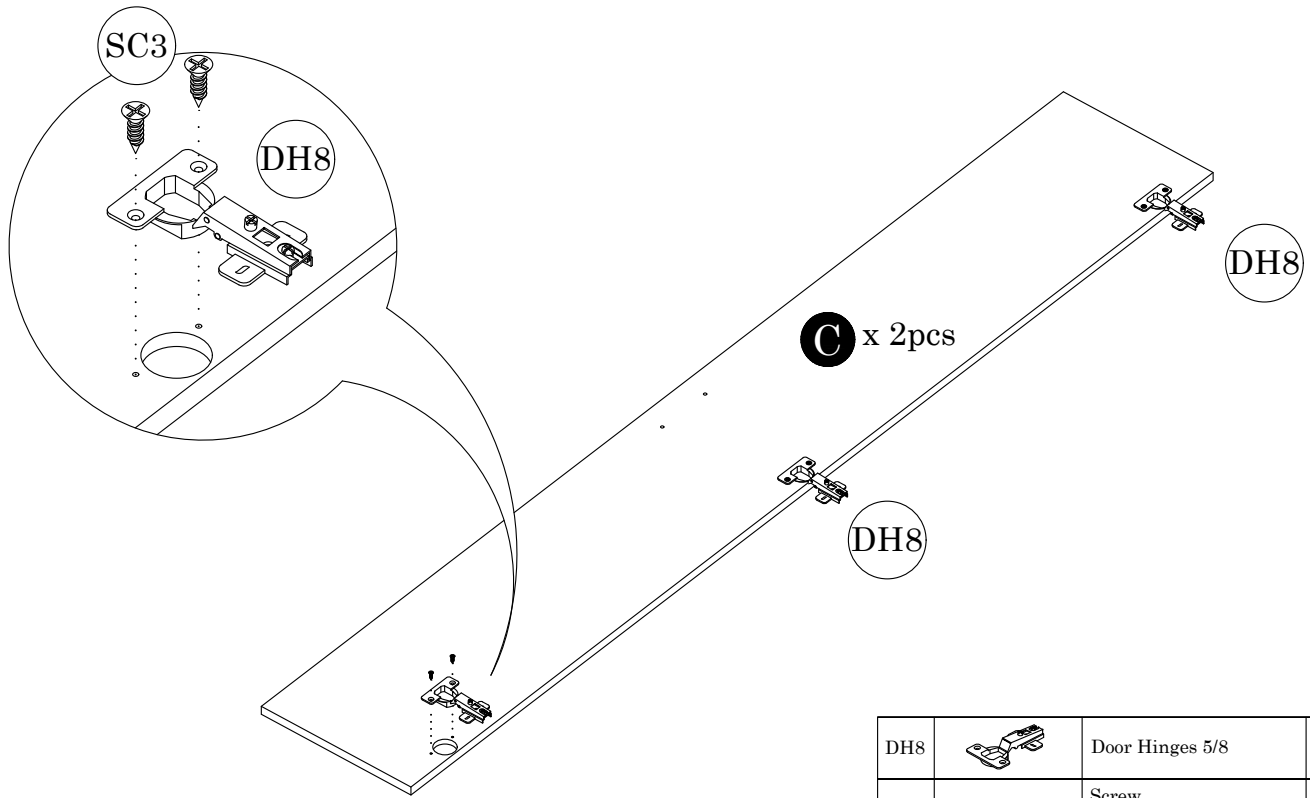

*There are no ready screw holes to fixed the 4 Legs (LG7)
 *You can tighten the Leg (LG7) freely with given screw m3.5 x 14mm (SC4) x4 at any convenient location on the Panel G

STEP 3



DH8		Door Hinges 5/8	6
SC3		Screw M3.5mm x 14mm	12

STEP 4

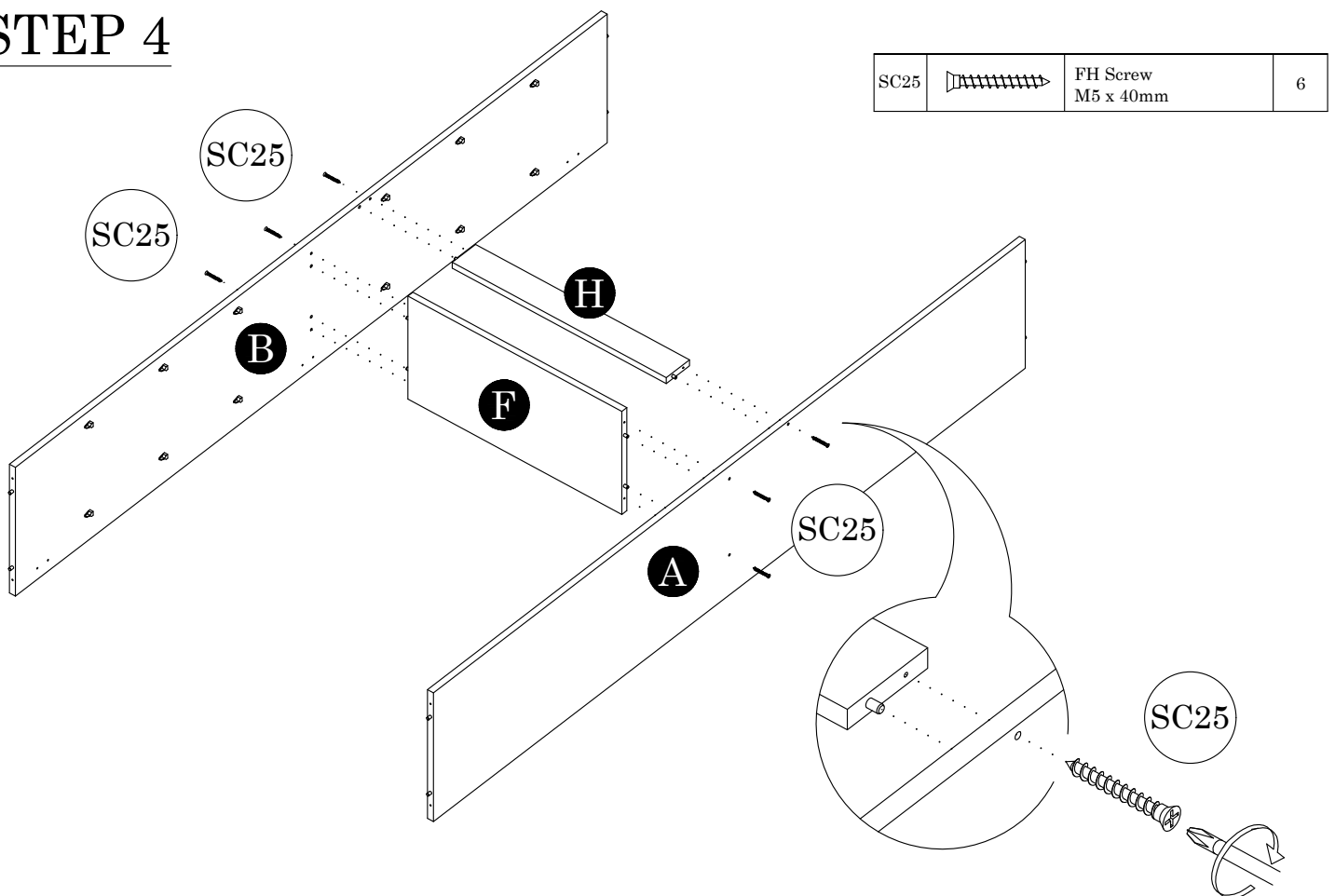

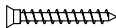
SC25		FH Screw M5 x 40mm	6
------	---	-----------------------	---

STEP 5

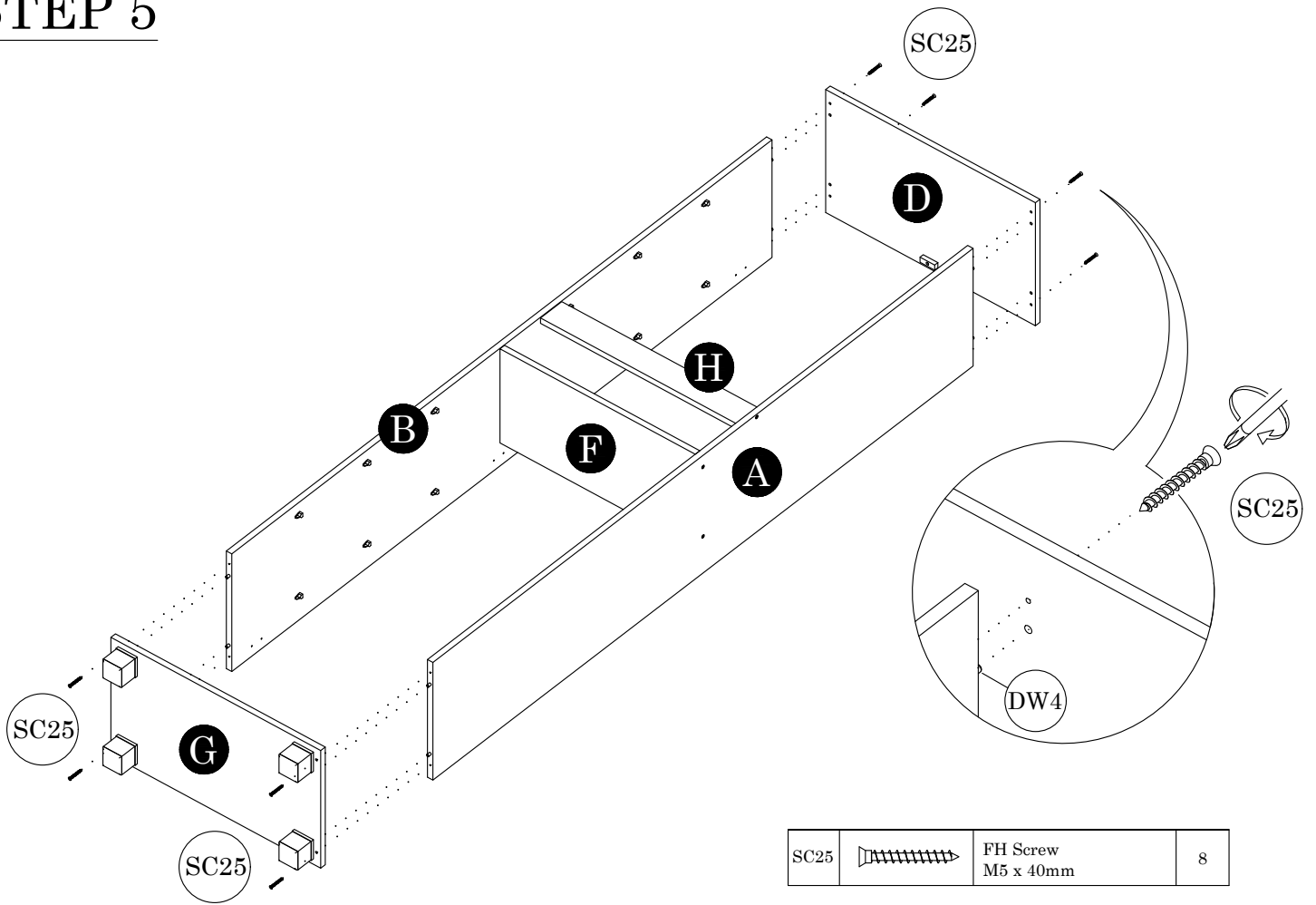

STEP 6

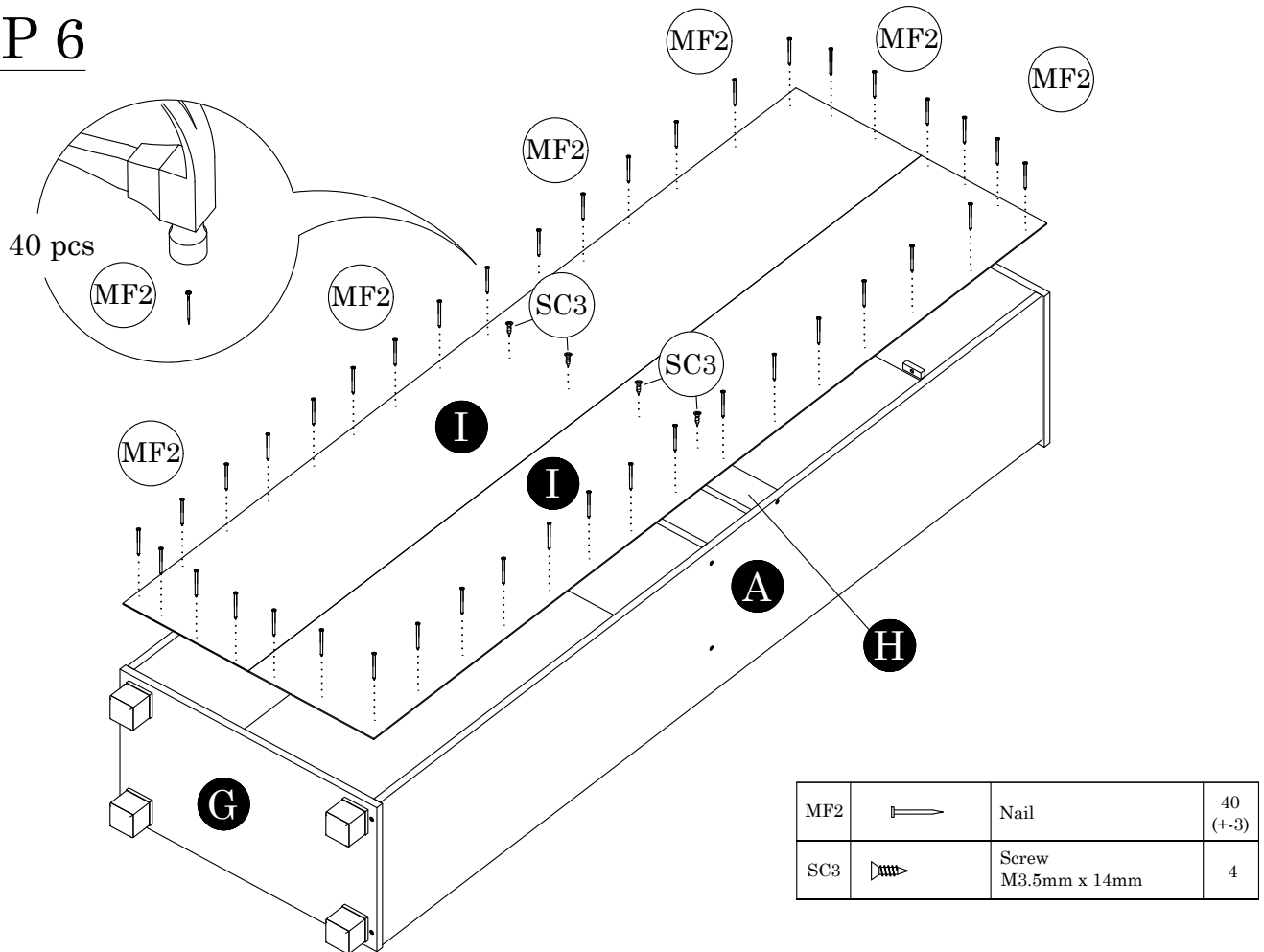

STEP 7



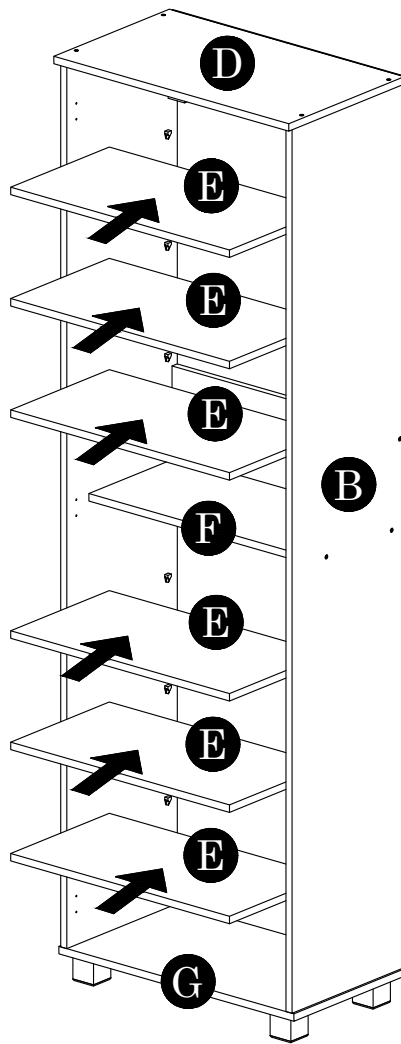

Insert 6pcs
free shelf panels

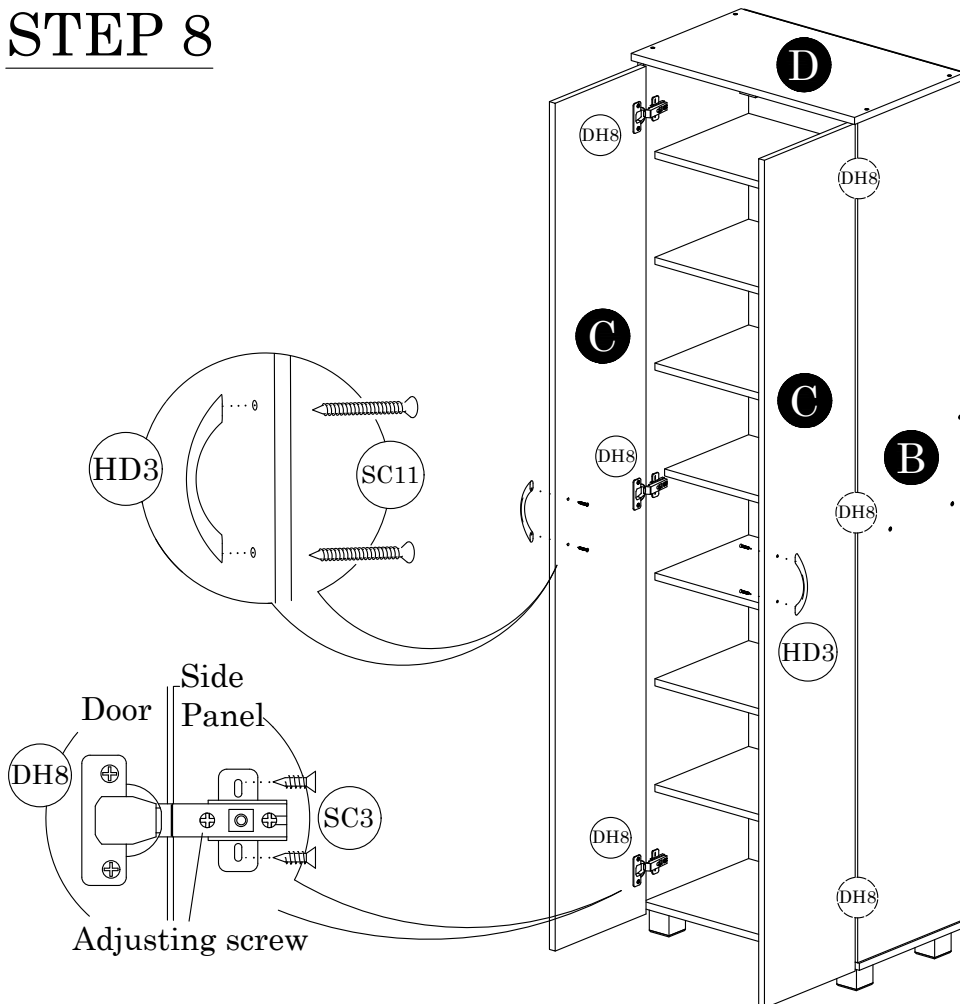

Stand
up

STEP 8



DH8		Door Hinges 5/8	6
HD3		Handle 96mm	2
SC3		Screw M3.5mm x 14mm	12
SC11		Screw M4 x 25mm	4